

Knob-Top 4" Delineator



RSPCTJK42H08

- ◆ Height 45" x Width 4"
- ◆ Knob Top for easy handling
- ◆ Accepts cone bars
- ◆ Caution tape wraps around knob
- ◆ Support rings around reflective bands for added tape protection
- ◆ Made from low density polyethylene Fluorescent Orange plastic
- ◆ 8 lb. base is standard and included in price, other sizes available upon request.



Channelizer Cone



RSPCC42NH4616
16 lb. base

- ◆ Plasticade Navicade Brand
- ◆ High Density Polyethylene
- ◆ 4 - 6" Tall High Intensity Orange and White Reflective stripes
- ◆ 3 lbs. / 49.25" H x 7.6" W
- ◆ 16 lb. Recycled rubber base included in 6" HIP version.
- ◆ Unique handle is easy to grab even with flashing light or sign attached
- ◆ Stackable with or without base for easy transportation or storage
- ◆ Molded-in holes for mounting lights and signs
- ◆ NCHRP-350 Accepted/Meets MUTCD Standards



30 lb. base (below)

Specifications	Standard	Additional Options Available
Stripe Width	4 Each - 6"	4 Each - 4" -or- 1 Each - 4" and 6"
Reflectivity	HIP	DG -or- DG/HIP Combo -or- ENG
Base	16 lbs.	30 lbs.
Stencil	NONE	Name or Logo Molded into Base

Gemstone™ Vertical Panel



RSPCV08346ORE
Standard

- ◆ Oversized handle with comfort grip
- ◆ Designed to withstand repeated impacts with minimal damage to vehicles or unit
- ◆ Recessed panel protects reflective sheeting, 8" W x 36" H
- ◆ Flashing light mounting receptacle
- ◆ Available in orange and white
- ◆ Solid recycled rubber bases with carrying handles come in two sizes: 20 lbs. and 30 lbs.
- ◆ Size: 15.4"W x 45" H Weight: 4 lbs.
- ◆ NCHRP-350 Accepted and Meets MUTCD Standards



20 lb. base



30 lb. base



The handle is easy to grab even with the light attached



Sidewall design adds strength and durability

Specifications	Standard	Additional Options Available
Color	Orange	White
Reflective Area	8" x 24"	8" x 34" -or- 8" x 36"
Stripe Size	4" for 8" x 24", 6" for 8" x 34" and 8" x 36"	4" for 8" x 34" and 8" x 36"
Reflectivity	ENG	HIP -or- DG
Base	20 lbs	30 lbs
Stencil	NONE	Name or Logo on Plastic Panel or Molded into Base

The Claw™ Delineator



RSPCTPC42E3
Standard

- ◆ Claw handle has comfort grip - easy placement and pick-up
- ◆ 2 sizes: 42" (52.375" with handle) and 28" (38.375" with handle)
- ◆ Recessed areas accept two bands of sheeting - protects retro-reflective sheeting from rips and scratches
- ◆ Bright orange for visibility
- ◆ Flange on bottom grabs base for tight fit
- ◆ Recycled rubber bases: 8 lbs, 10 lbs, 12 lbs, and 18 lbs
- ◆ NCHRP-350 Accepted and Meets MUTCD Standards



Available Bases
8 lb. base
10 lb. base
12 lb. base
18 lb. base



Great for Caution Tape



Comfort Grip Handle

Specifications	Standard	Additional Options Available
Height	42" (52.375" with handle)	28" (38.375" with handle)
Reflectivity	ENG	NONE -or- HIP -or- DG
Band (Stripe Width)	2 Each - 3"	2 Each - 4"
Rubber Base	8 lbs.	10 lbs., 12 lbs. -or- 18 lbs.
Handle	The Claw	No Handle, Open Top Delineator available for slightly less money

Attenuator Barrels



Attenuator Barrels

- ◆ Traffix Big Sandy brand
- ◆ All Complete Barrels with Lid
- ◆ Sand leaking is eliminate because each sand container is one piece with NO Edge Seals.
- ◆ Easy shipping, storing and installation.
- ◆ NCHRP-350 Accepted and meets MUTCD Standards



RSPUXBS24700 200, 400, 700 lb Barrel Combo

Channelizer Traffic Drums



- ◆ Plasticade Econocade II Brand
- ◆ High density plastic
- ◆ 4 - 6" Tall High Intensity Orange and White Reflective stripes
- ◆ 8 lbs. / 40.02" H x 22.94" W
- ◆ 25 lb. Recycled tire base, order separately.
- ◆ Tire Locking Ring™
- ◆ Comfort grip handle for secure, easy pick-up
- ◆ Innovative "light ledge" keeps light upright
- ◆ Thick walls make this drum rugged and durable
- ◆ NCHRP-350 Accepted and meets MUTCD Standards

Specifications	Standard	Additional Options Available
Stripe Width	(2) 6" Orange / (2) 6" White	(2) 4" Orange / (2) 4" White
Reflectivity	HIP	DG -or- ENG
Density	HIGH	LOW
Base	Tire Ring	Sand Fillable- requires purchasing another model
Stencil	NONE	Molded in Name or Logo

Type I & II Barricades



Combocade™ Type I and Type II Barricade

- ◆ Steel leg barricade with your choice of aluminum, plastic, or plywood boards
- ◆ Boards and legs can be replaced, legs can be repaired
- ◆ 45" steel legs, 14 gauge thickness, galvanized - white powder coated finish available by special order
- ◆ Plastic boards are strong and dense, will not bend, warp, crack, splinter, or peel
- ◆ Bolt holes are molded into the plastic boards
- ◆ Dimensions: 24.4" W x 42.6" H
Board Sizes Available: 8" x 24" and 12" x 24"
- ◆ NCHRP-350 Accepted/Meets MUTCD Standards

Specifications	Standard	Additional Options Available
Reflectivity	ENG	HIP -or- DG
Reflective Area Type I Barricade	8" x 24" Top Panel	12" x 24" Top Panel
Reflective Area Type II Barricade	8" x 24" Top Panel 8" x 24" Bottom Panel	12" x 24" Top Panel 8" x 24" Bottom Panel
Usage	Type I or Type II Barricade	Safety Signage
Stencil	NONE	Recommended for Type I Only
Purchase Option	Complete Barricade	Replacement Parts

Purchase barricades fully assembled or as component parts.

Names can be stenciled on blank panels for identification.

Leg hinge hole accepts 1/2" light mounting bolt



Econocade® Type I and Type II Barricade



RSPB1PPE2WHE0808
TYPE II

- ◆ One piece solid construction
- ◆ Size: 24.4" x 42.6"
- ◆ Easy to handle, pack, and transport.
- ◆ Rust free and impact resistant.
- ◆ Bottom rail can carry a sand bag.
- ◆ Two flashing light receptacles
- ◆ White in Stock. Also available in Orange, Yellow, Red, Blue and Green.
- ◆ NCHRP-350 Accepted and meets MUTCD Standards



RSPB1PPE1WHE08
TYPE I

The Econocade Barricade can be purchased in a variety of colors.

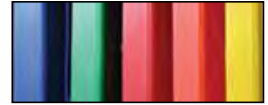

Specifications	Standard	Additional Options Available
Body Color	White	500 Piece Minimum: Orange, Red, Yellow, Green or Blue
Reflectivity	ENG	HIP -or- DG
Reflective Area Type I Barricade	8" x 24" Top Panel	12" x 24" Top Panel
Reflective Area Type II Barricade	8" x 24" Top Panel 8" x 24" Bottom Panel	12" x 24" Top Panel 8" x 24" Bottom Panel
Usage	Type I or Type II Barricade	Safety Signage
Stencil	NONE	Recommended for Type I Only

Plasticade® Type I and Type II Barricade



RSPB1PPPL2WHH08
TYPE II

- ◆ Premium Plasticade Barricade
- ◆ Withstands repeated impacts
- ◆ Molded-in handles with mounting holes for attaching flashing lights
- ◆ "Click lock" hinges for a positive interlock in the open position
- ◆ Internal ballasting, up to 10 lbs. of sand
- ◆ Sandbag bar (for additional weight)
- ◆ White in Stock. Also available in Orange and Yellow.
- ◆ All grades of reflective sheeting available.
- ◆ Stacking lugs keep units from sliding when stacked
- ◆ NCHRP-350 Accepted and meets MUTCD Standards



RSPB1PPPL1WHH08
TYPE I



RSPB1PPPL2WHH12
TYPE II



Add a Sign Sleeve to use as a sign stand



Stenciling Available

Specifications	Standard	Additional Options Available
Body Color	White -or- Orange	Yellow
Reflectivity	HIP	ENG -or- DG
Reflective Area Type I Barricade	8" x 24" Top Panel	12" x 24" Top Panel
Reflective Area Type II Barricade	8" x 24" Top Panel 8" x 24" Bottom Panel	12" x 24" Top Panel 8" x 24" Bottom Panel
Usage	Type I or Type II Barricade	Sign Stand with Sign Sleeve Option -or- Safety Signage
Stencil	NONE	Recommended for Type I Only

Specifications	Standard	Additional Options Available
Leg	Plasticade A-frame	Econocade A-frame
Board	1" x 8" Plastic Board	I-BEAM Board
Board Quantity	2	1
Length	8'	6'-or- 10'-or- 12'
Reflective Sides	2	1
Reflectivity	HIP	DG -or- ENG
Base	20 lbs	30 lbs
Stencil	NONE	Recommended on Leg
Purchase Option	Kits	Replacement Parts

Plasticade® A-Frame Barricade

- ◆ Rugged, large A-frame plastic barricade
- ◆ Perfect for crowd control and road closures
- ◆ Easy to set up, transport, and store
- ◆ Use with one or two boards
- ◆ Light mounting receptacle on each leg
- ◆ Legs can be ballasted with sand
- ◆ Choose boards from Type III Section

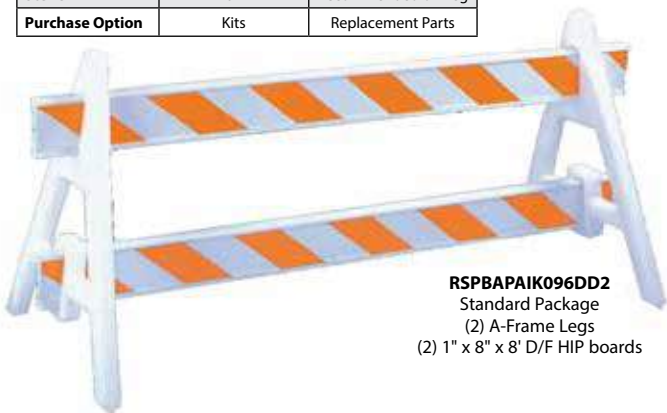

RSPBAPAIK096DD2
Standard Package
(2) A-Frame Legs
(2) 1" x 8" x 8' D/F HIP boards



One Board Set (right)
Two Board Set (left)

Type III Barricades



Telespar® Uprights with Telespar® Feet



Extruded Hollow Core with Internal Walls for Strength and Durability.

Options Available

- ◆ Telespar® uprights with Telespar® feet
- ◆ Telespar® uprights with Angle Iron feet
- ◆ Angle Iron uprights with Angle Iron feet



Telespar® Uprights with Angle Iron Feet

- ◆ NCHRP-350 Approved and Meets MUTCD Standards
- ◆ 1" x 8" Wide plastic boards available in 4', 6', 8', 10', and 12' lengths.
- ◆ Specify length in inches (96).
- ◆ High Intensity Prismatic, Engineer Grade or Diamond Grade Sheeting.
- ◆ Choose Single or Double faced
- ◆ Specify right (R) or left (L) on single faced boards.
- ◆ Specify (OW) for Orange/White or (RW) for Red/White.
- ◆ Quick removal of uprights from feet - Allows for short term or permanent placement
- ◆ Easy to assemble and replace parts if necessary
- ◆ Accepts two flashing lights

Break-a-way System with shear pin design includes:

- ◆ 2-5' x 1 3/4" Galvanized square post, 12 gauge metal;
- ◆ 2-5' x 1 1/2" Galvanized square post uprights, 12 gauge metal;
- ◆ 2-6" x 1 3/4" Galvanized square stubs, 12 gauge metal;
- ◆ 2 breakaway shear pin assembly kits

Part #	Description	Part #	Description
RSPB3Z(XX)NM	Boards Unsheeted	RSPB3Z(XX)SHMS(L)OW6	Board HIP S/F
RSPB3Z(XX)SEMS(L)OW6	Board ENG S/F	RSPB3Z(XX)SHMDOW6	Board HIP D/F
RSPB3Z(XX)SEMDOW6	Board ENG D/F	RSPB3ZBUS	Breakaway Upright

Specifications	Standard	Additional Options Available
Length	8' (96")	4'(48"), 6'(72"), 10'(120"), 12'(144")
Reflective Sides	1 - Single Sided	2 - Double Sided
Reflectivity	HIP	DG -or- ENG
Stripe Pattern	6" Left or Right Stripe	6" Chevron Pattern
Stripe Color	Orange & White	Red & White: End of Road Barricade
Stencil	NONE	Recommended on white plastic portion only
Breakaway Upright System	Steel Square Post System	Plasticade All Plastic Systems -or- Sentinel All Plastic System (4' & 6' only) -or- Angle Iron Steel System
Purchase Options	Replacement Parts	Kits

Telespar® & Angle Iron Barricades are sold in kits with three boards with your choice of sheeting. Sheeting can be on one side of the boards or both. All hardware needed for assembly is included in the kit.

Telespar®

- ◆ Square shape provides superior wind load capabilities and inhibits warping
- ◆ Uprights and feet - 14 gauge
- ◆ Galvanized, hot rolled high carbon steel
- ◆ Pre-punched universal mounting holes - 7/16" diameter.

Angle Iron

- ◆ Uprights are 10 gauge, galvanized steel
- ◆ Holes for boards - 11/32" diameter, holes for lights 9/16" diameter
- ◆ Feet are 10 gauge steel, mill finish

ALL Plastic Type III Barricades



Plasticade® Break-Away

- ◆ Collapsible, lies flat for storage and transport
- ◆ Available with 6 board lengths: 1" x 8" boards, 4', 6', 8', 10' or 12' long
- ◆ Easier to transport, install, and store than wood or steel Type III Barricades
- ◆ Boards are available sheeted (one or both sides) or unsheeted
- ◆ Accepts two flashing lights
- ◆ Barricades are sold in kits with hardware included or as component parts
- ◆ NCHRP-350 Accepted, Meets MUTCD Standards

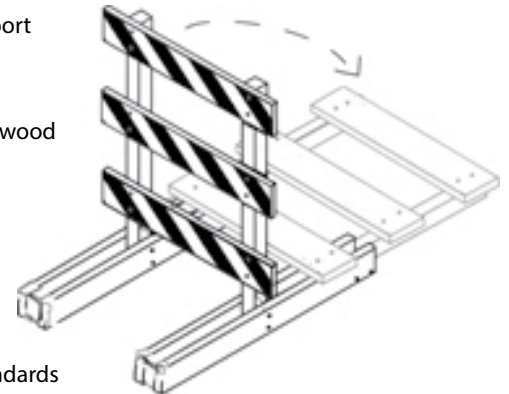

Sentinel™

- ◆ Easy to assemble base consists of 2 pieces, upright and base, that snap together, no hardware required.
- ◆ Available with two board lengths: 1" x 8" boards, 4' or 6' long
- ◆ Boards can be purchased sheeted (on one or both sides) or unsheeted
- ◆ Base can be internally ballasted with sand, sandbags, or water in warmer climates
- ◆ NCHRP-350 Accepted, Meets MUTCD Standards





Easy-Fold Sandwich Boards are a great option for Temporary Traffic Control when ease of use and portability are a must.

- ◆ Choose from 3 sizes and 3 colors: White, Yellow or Orange
- ◆ 51 Standard Legends; *Custom Legends* also available.
- ◆ Hassle-free, guaranteed, professional application available on legends.
- ◆ Available as a blank, single or double sided.
- ◆ Sheeting: High Intensity (H), Diamond Grade (D) or Engineer Grade (E)
- ◆ School Zone Sign Sheeting: FYG VIP only (D)
- ◆ May be internally ballasted with sand.

Narrowcade®

Holds signs 12"W x 24"H
Dimensions: 45"H x 13"W
Item # Weight: 11 lbs.

Minicade®

Holds signs 12"W x 24"H
Dimensions: 36"H x 13"W
Item C155 Weight: 10 lbs.

Signicade®

Holds signs 24"W x 36"H
Dimensions: 45"H x 25"W
Item C130 Weight: 18 lbs.

Specifications	Standard	Additional Options Available
Colors	White or Orange	Yellow
Reflectivity	ENG	HIP -or- DG
Usage	Barricade and Vertical Panel	Safety Signage
Flashing Light	NONE	Flashing Light attachment available

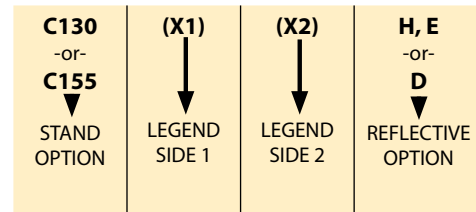

CODE	LEGEND/COLOR SCHEME	CODE	LEGEND/COLOR SCHEME	CODE	LEGEND/COLOR SCHEME	CODE	LEGEND/COLOR SCHEME
1005	10 MPH	1049	EXIT →	1102	PARKING LOT CLOSED	1162	STOP
1006	15 MPH	1016L	LEFT ARROW	1104	PARKING LOT FULL	1164	STOP FOR PEDESTRIANS IN CROSSWALK
1007	20 MPH	1016R	RIGHT ARROW	1120	ROAD CLOSED	1170	STOP POLICE CHECK POINT
1133	SLOW - Vertical	1073	← KEEP LEFT	1080	LANE CLOSED	1142	SLOW POLICE CHECK POINT AHEAD
1443	SLOW - Horizontal	1074	KEEP RIGHT →	1092	NO LEFT TURN	1177	STOP SOBRIETY CHECK POINT
1465	SLOW WORK ZONE AHEAD	1043	← DETOUR	1095	NO RIGHT TURN	1150	SLOW SOBRIETY CHECK
1147	SLOW SCHOOL ZONE AHEAD	1044	DETOUR →	1084	MEN WORKING	1148	SLOW SHERIFF CHECKPOINT
9278	SCHOOL CROSSING	1046	DO NOT ENTER	1086	MOWING AHEAD	1134	SLOW ACCIDENT AHEAD
1126	SCHOOL ZONE 10 MPH	1061	FUNERAL NO PARKING	1180	SURVEY CREW AHEAD	1136	SLOW EMERGENCY AHEAD
1127	SCHOOL ZONE 15 MPH	1093	NO PARKING	1190	TREE WORK AHEAD	1140	SLOW PEDESTRIAN CROSSING
1128	SCHOOL ZONE 20 MPH	1098	← PARKING	1190	UTILITY WORK AHEAD	1200	LEFT BARRICADE
1091	← NO EXIT	1099	PARKING →	1196	FLAGMEN AHEAD	1210	RIGHT BARRICADE
1048	EXIT	1100	↑ PARKING	1198	RESERVED		

Caution Tape • Marking Flags • Barricade Sheeting



RSP710(X)



RSP950(XX)



Red/White NOW AVAILABLE

- ◆ 3 mil : 3" x 1000' Poly barrier tape provides warning of temporary safety hazard
- ◆ Economical, strong, and disposable
- ◆ **Legends:**
 - (A) Caution Caution
 - (B) Police Line Do Not Cross
 - (F) Caution Do Not Enter
- ◆ Other sizes and legends

- ◆ 4" x 5" - 21" Wire staff
- ◆ Glo Colors: Orange (OR), Green (GR), Pink (PK), Yellow (YL), and Blue (BL) (*min qty of 100*)
- ◆ Other colors, sizes, and custom printed flags available (*min qty of 1,000*)

- ◆ 50 Yard Rolls
- ◆ Engineer Grade (E) in 6" or 8" widths
- ◆ High Intensity Prismatic (H) in 8" wide
- ◆ Specify 4" (4) or 6" (6) stripe and right (R) or left (L) slant where appropriate

50 Yard Roll Part #	Width & Type	Stripe Width	Colors
RSHCN8117(L)60650	6" (E)	6"	O/W
RSHCN8117(L)40850	8" (E)	4"	O/W
RSHCN8117(L)60850	8" (E)	6"	O/W
RSH333(6)(L)0850	8" (H)	6"	O/W
RSHCN8115(L)60850	8" (E)	6"	R/W
RSHCN515(L)60850	8" (H)	6"	R/W



Barriers & Barricades

CONSTRUCTION WORK ZONE



Use Strongwall to create ADA compliant walkway



May be used as a longitudinal channeling device



Strongwall ADA Pedestrian Barricade

- ◆ ADA Compliant, no trip hazard for pedestrians
- ◆ Meets or exceeds ADA Guidelines and MUTCD Standards
- ◆ Linking sections are made up of two pieces that securely fit together
- ◆ Top Wall - rugged polyethylene
- ◆ Bottom Base - 43 lbs. self weighted black base with carry handle. Stable in windy conditions, no sandbags needed!
- ◆ Modular system can be shaped to any layout and is quick and easy to install
- ◆ Anti-tamper linking system - difficult for unauthorized personnel to dismantle when linked
- ◆ Compact stacking lowers transport costs
- ◆ Available in orange or white with or without retro-reflective sheeting.

Single Section w/Base
43" L x 15.5" w x 40" H
Weight: 51 lbs.



Carry Handle

RSPCSWPSZB
Base Dimensions
40.4" L x 15.5" W x 12" H



RSPCSWPSLO
Orange

RSPCSWPSZB
Base

RSPCSWPSAW



RSPCSWPSAO

ADA Compliant

Sheeting Area
6" x 30"
on both sides

ADA Compliant

RSPCSWPSLW
White

Sheeting Area
6" x 30"
on both sides

Single Section w/Base
43" L x 15.5" w x 32" H Weight: 50 lbs.

Specifications	Standard	Additional Options Available
Color	Orange	White -or- Alternating Orange & White
Reflective Sides	2	1 on pedestrian side -or- 1 on outside
Reflectivity	NONE	HIP -or- ENG
Use of water or sand bags for stabilization	NONE: the base design eliminates the need	Fillable with 33# of water
Purchase Options	Strongwall and Base	Same inventory of bases can be used for ADA & LCD Strongwalls

Strongwall LCD Longitudinal Channelizing Device

- ◆ Limits access to work zones- provides a continuous path for motorists and pedestrians with all the same standard features and base as the Strongwall ADA Pedestrian Barricade.

Avalon Crowd Control Barrier

- ◆ Linking design creates secure, tamper free, connections - units adjust to uneven ground
- ◆ High visibility, anti-trip feet
- ◆ Panels on both sides for retro-reflective sheeting
- ◆ Holes for signs to be affixed
- ◆ Adjusts to uneven ground

Sheeting Area 5.5" x 51" on both sides

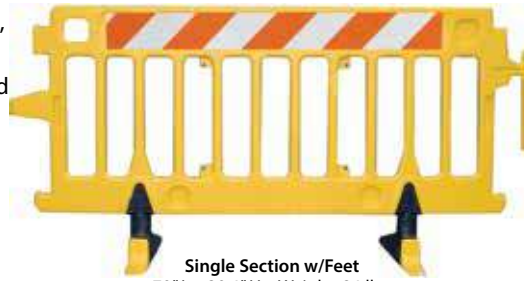

Single Section w/Feet
79" L x 39.4" H Weight: 24 lbs.

Specifications	Standard	Additional Options Available
Color	Orange	Yellow, White, Blue -or- Custom
Reflective Sides	2	1 on pedestrian side -or- 1 on outside
Reflectivity	NONE	HIP -or- ENG
Stencil	NONE	3.9" x 21.65" area for stenciling -or- 3" x 3.5" are for numbering
Decals or Logos	NONE	In reflective, stencil -or- number area
Purchase Options	Complete Barriers	Replacement Feet



Standard Item# RSPCSPA0 (Shown Above)



NON CONDUCTIVE
No Metal Used

Safegate Manhole Guard

RSPCPCBSGMG



Single Unit
29.5" L x 39.4" H
Weight: 4.4 lbs.

- ◆ Ideal for Utility Work
- ◆ Non-conductive (dielectric), no metal used
- ◆ Great for protecting any area requiring temporary restriction of access
- ◆ Hinged clips make it easy to configure sections into rectangles of various sizes - locking clamp to be used for straight sections
- ◆ Folds up for storage and sets up quickly
- ◆ Carry handles for transport
- ◆ Longer life than metal, replacement sections available
- ◆ Available in yellow

Trench Covers & Curb Ramps

• Lighter than Steel • Stronger than Wood • Anti-Slip Surface • Deters Metal Thieves •



27" Trench Cover
47.2" L x 31.5" W
Weight: 26.5 lbs.



50" L x 38.5" W x 3" H
Weight: 13.2 lbs.



44.3" L x 44.3" W
Weight: 62 lbs.

Trench Covers - 27" or 35"

- ◆ Two sizes - designed to cover trenches up to 27" or 35".
- ◆ Takes the vehicle weight up to 4,410 lbs.
- ◆ Beveled edge prevents tripping
- ◆ Molded from a single piece of fiberglass composite - underside has ribbed framework for added strength
- ◆ Recommended bolting to road surface



35" Trench Cover
63" L x 47.2" W
Weight: 73 lbs.

SafeKerb Ramp

- ◆ Adapts to curb heights from 3" to 6.3"
- ◆ Withstands loads up to 553 lbs.
- ◆ Raised sides prevent vehicle run off
- ◆ Molded from high density polyethylene
- ◆ Stacks for transport and storage
- ◆ Bolt to road and walkway surface for added stability



Road Plate: 59" L x 19.7" W / Weight - 96.8 lbs.
End Section: 59" L x 19.7" W / Weight - 50.6 lbs.

Pedestrian Trench Cover

- ◆ Pedestrians Only - takes up to 553 lbs.
- ◆ Covers trenches up to 27.5"
- ◆ Smooth rubber edge greatly reduces tripping hazard
- ◆ Resists sliding, no need to bolt down - flexible material which grips the surface to underneath

Road Plate

- ◆ Easy to install modular system with no special equipment needed, weighs 97 lbs. per section
- ◆ Tested to vehicle weights of 96,800 lbs - Single wheel load, 14,520 lbs.
- ◆ No rust or corrosion
- ◆ Long lasting polymer material
- ◆ No "rattle" from crossing vehicles
- ◆ Design slows traffic for increased safety
- ◆ Features "Drop Pins" that increase stability - pins protrude into trench preventing lateral movement of plate
- ◆ Steel linking brackets lock sections together
- ◆ End sections must be bolted to ground in order to lock unit into position
- ◆ Stacks securely for transportation and storage

Specifications		
Traffic Type	Vehicle & Pedestrian	Pedestrian Only
	27" Trench Cover 35" Trench Cover Road Plate	Ped Trench Cover SafeKerb Ramo
Trench Widths	Up to 27" Wide	Up to 35" Wide
	27" Trench Cover 35" Trench Cover Road Plate Ped Trench Cover	35" Trench Cover Road Plate
Vehicle Weight Limit	Up to 4,410 Lbs	Up to 14,520 lbs per wheel
	27" Trench Cover 35" Trench Cover Road Plate	Road Plate



CONSTRUCTION WORK ZONE

Class 2 Safety Vests



RSAGV20SDVM(XX)N Orange
RSAGV2LSDVM(XX)N Yellow Green

3M Mesh Economy Vest

Specify Size - (L), (XL), (2X)
ANSI/ISEA 107-2004 Class 2 Level 2
Velcro Closure Vest with 1 3/8" 3M™
Scotch-lite Silver Heat-On Striping.



Mesh Chevron Vest

Specify Size - (XL), (2X)
ANSI/ISEA 107-2004 Class 2 Level 2
Zipper Closure with 3M™ Scotch-lite High Gloss
Silver or Lime Stripes and Adjustable Side Straps.

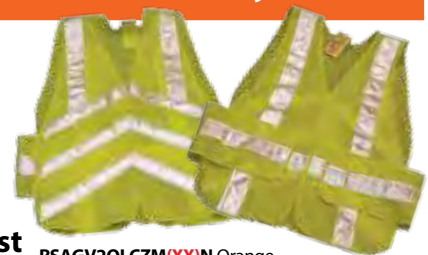

RSAGV20LCZM(XX)N Orange
RSAGV2LSCZM(XX)N Yellow Green



Construction Work Zone Signs

CWZ Signs can be ordered with 500 ft (05) • 1000 ft (10) • 1500 ft (15) • 1/2 mile (5M) • 1 mile (1M) • Ahead (AH) Example: S4848W202(AH)(X)AC



S3030W202(XX)(X)AC
S3636W202(XX)(X)AC
S4848W202(XX)(X)AC



S3030W203(XX)(X)AC
S3636W203(XX)(X)AC
S4848W203(XX)(X)AC



S3030W204(XX)(X)AC
S3636W204(XX)(X)AC
S4848W204(XX)(X)AC



S3030W205L(XX)(X)AC
S3636W205L(XX)(X)AC
S4848W205L(XX)(X)AC



S3030W205R(XX)(X)AC
S3636W205R(XX)(X)AC
S4848W205R(XX)(X)AC



S3030W213(XX)(X)AC
S3636W213(XX)(X)AC
S4848W213(XX)(X)AC



S3030W201(XX)(X)AC
S3636W201(XX)(X)AC
S4848W201(XX)(X)AC



S3030W217(XX)(X)AC
S3636W217(XX)(X)AC
S4848W217(XX)(X)AC



S3030W205AL(XX)(X)AC
S3636W205AL(XX)(X)AC
S4848W205AL(XX)(X)AC



S3030W205AR(XX)(X)AC
S3636W205AR(XX)(X)AC
S4848W205AR(XX)(X)AC



S3030W215BL(XX)(X)AC
S3636W215BL(XX)(X)AC
S4848W215BL(XX)(X)AC



S3030W215BR(XX)(X)AC
S3636W215BR(XX)(X)AC
S4848W215BR(XX)(X)AC

CONSTRUCTION WORK ZONE

Huge Selection*
IN STOCK
READY TO
SHIP SIGNS

*Call customer service for current availability.

48" Signs Must Ship Truck Line

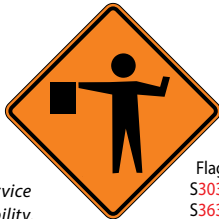

Flagger Symbol
S3030W207(X)AC
S3636W207(X)AC
S4848W207(X)AC



S3030W34(X)AC
S3636W34(X)AC
S4848W34(X)AC

To stay in compliance with the MUTCD, we recommend using **3M™** Diamond Grade Fluorescent Orange or High Intensity Prismatic for **Construction Work Zone Signs**



Men Working Symbol
S3030W211(X)AC
S3636W211(X)AC
S4848W211(X)AC



S2424W211B(X)AC
S3030W211B(X)AC
S3636W211B(X)AC
S4848W211B(X)AC



S3030W211C(X)AC
S3636W211C(X)AC
S4848W211C(X)AC



S3030W212(X)AC
S3636W212(X)AC
S4848W212(X)AC



S3030W212T(X)AC
S3636W212T(X)AC
S4848W212T(X)AC



S3030W811(X)AC
S3636W811(X)AC
S4848W811(X)AC



S3030W812(X)AC
S3636W812(X)AC
S4848W812(X)AC



S3030W241(L)(X)AC
S3636W241(L)(X)AC
S4848W241(L)(X)AC



S3030W241A(R)(X)AC
S3636W241A(R)(X)AC
S4848W241A(R)(X)AC



S3030W241B(R)(X)AC
S3636W241B(R)(X)AC
S4848W241B(R)(X)AC



S3030W93(X)AC
S3636W93(X)AC
S4848W93(X)AC



S3030W215(X)AC
S3636W215(X)AC
S4848W215(X)AC



S3030W215AL(X)AC
S3636W215AL(X)AC
S4848W215AL(X)AC



S3030W215AR(X)AC
S3636W215AR(X)AC
S4848W215AR(X)AC



S3030W216(X)AC
S3636W216(X)AC
S4848W216(X)AC



S3030W221(X)AC
S3636W221(X)AC
S4848W221(X)AC



S2412M48(X)AC



S2418M48A(X)AC



S3024M49L(X)AC



S3024M49R(X)AC



S3024M49BL(X)AC



S3024M49BR(X)AC



S3024M49CL(X)AC



S3024M49CR(X)AC



S3024M49AL(X)AC



S3024M49AR(X)AC



S4836E52(X)AC



S2412M48B(X)AC

ACM Sheets



- ◆ 3mm Aluminum Composite Material (ACM) is made of two sheets of .021 Aluminum bonded to a thermoplastic core.
- ◆ ACM's flat rigid surface and weather resistance ensures long-term performance and durability.
- ◆ ACM is lightweight at only .8 lbs per square foot.
- ◆ Available as Bare, Sheeted or as a Finished Sign.

RBACM3MM4896WHAL - 48" x 96"

Temporary Traffic Control Zone



S1818W131P10(X)AC
S2424W131P10(X)AC



S1818W131P15(X)AC
S2424W131P15(X)AC



S1818W131P20(X)AC
S2424W131P20(X)AC



S1818W131P25(X)AC
S2424W131P25(X)AC



S3648W143(X)AC



S3618G201B(X)AC
S4824G201B(X)AC
S6024G201B(X)AC
*Specify miles



S4818M410L(X)AC



S1818W131P30(X)AC
S2424W131P30(X)AC



S1818W131P35(X)AC
S2424W131P35(X)AC



S1818W131P40(X)AC
S2424W131P40(X)AC



S1818W131P45(X)AC
S2424W131P45(X)AC



S3618G202(X)AC
S4824G202(X)AC



S3618G204(X)AC



S4818M410R(X)AC

Temporary CWZ Roll-Up Signs

Fluorescent Roll-Up Sign Materials:

3M Diamond Grade (D)

3M High Intensity (H)

Econo Mesh Non-Reflective (N)



Available in 36"x36" (36) and 48"x48" (48) sizes with vinyl pockets. *Many of these legends and sizes are in stock for quick shipment.*



CONSTRUCTION WORK ZONE

Quantity Discounts Available

Part #	Legend	Part #	Legend	Part #	Legend
RMS(XX)W34(N)	Be Prepared To Stop	RMS(XX)W204AH(N)	One Lane Road Ahead	RMS(XX)W216AH(N)	Survey Crew Ahead
RMS(XX)W221(N)	Blasting Zone	RMS(XX)W205R(N)	Right Lane Closed	RMS(XX)W414(N)	Trucks Entering Highway
RMS(XX)W202AH(N)	Detour Ahead	RMS(XX)W205R10(N)	Right Lane Closed 1000 FT	RMS(XX)W217AH(N)	Utility Work Ahead
RMS(XX)W207AAH(N)	Flagger Ahead	RMS(XX)W205R15(N)	Right Lane Closed 1500 FT	RMS(XX)W2171M(N)	Utility Work 1 Mile
RMS(XX)W207(N)	Flagger Ahead Symbol	RMS(XX)W205R05(N)	Right Lane Closed 500 FT	RMS(XX)W2175M(N)	Utility Work 1/2 Mile
RMS(XX)W207BAH(N)	Flagman Ahead	RMS(XX)W205RAH(N)	Right Lane Closed Ahead	RMS(XX)W21705(N)	Utility Work 500 FT
RMS(XX)W42L(N)	Lane Ends Merge Left Symbol	RMS(XX)W205R1M(N)	Right Lane Closed 1 Mile	RMS(XX)W21710(N)	Utility Work 1000 FT
RMS(XX)W42R(N)	Lane Ends Merge Right Symbol	RMS(XX)W205R5M(N)	Right Lane Closed 1/2 Mile	RMS(XX)W21715(N)	Utility Work 1500 FT
RMS(XX)W205L1M(N)	Left Lane Closed 1 Mile	RMS(XX)W203(N)	Road Closed	RMS(XX)W211AAH(N)	Workers Ahead
RMS(XX)W205L5M(N)	Left Lane Closed 1/2 Mile	RMS(XX)W203AH(N)	Road Closed Ahead	RMS(XX)W218AH(N)	Work Area Ahead
RMS(XX)W205L10(N)	Left Lane Closed 1000 FT	RMS(XX)W2015M(N)	Road Work 1/2 Mile	RMS(XX)W211(N)	Workers Symbol
RMS(XX)W205L15(N)	Left Lane Closed 1500 FT	RMS(XX)W2011M(N)	Road Work 1 Mile	NOTE: Order Sign Ribs Separately.	
RMS(XX)W205L05(N)	Left Lane Closed 500 FT	RMS(XX)W201AH(N)	Road Work Ahead		
RMS(XX)W205L(N)	Left Lane Closed	RMS(XX)W20105(N)	Road Work 500 FT	RMSR36	36" Roll-Up Sign Ribs
RMS(XX)W205LAH(N)	Left Lane Closed Ahead	RMS(XX)W20110(N)	Road Work 1000 FT	RMSR48	48" Roll-Up Sign Ribs
RMS(XX)W211B(N)	Men Working	RMS(XX)W20115(N)	Road Work 1500 FT		
RMS(XX)W211C(N)	Mowers Ahead	RMS(XX)SWC(N)	Sheriff's Work Crew		

Safety Flags



RSPFLAG VINYL1824
18x18 • 24" dowel

RSPFLAGMESH1824
18x18 • 24" dowel
RSPFLAGVINYL2436
• 24x24 • 36" dowel

- ◆ 18" or 24" Fluorescent Red/Orange vinyl coated nylon or mesh available
- ◆ 24" flag required for flagging operations
- ◆ 18" or 24" flag suitable to mount above a traffic control sign or device
- ◆ 3/4" wood dowels

SMV Emblem • Conspicuity Tape



RVSSMV10 Aluminum
RVSSMV20 Decal

Choose Aluminum or Decal



RVSCT980320250

- ◆ 2" x 50 yds with red and white pattern repeats
- ◆ Meets all requirements for marking vehicles



Work Zone Sign Stands

GT2 Galvanized Tripod Stand

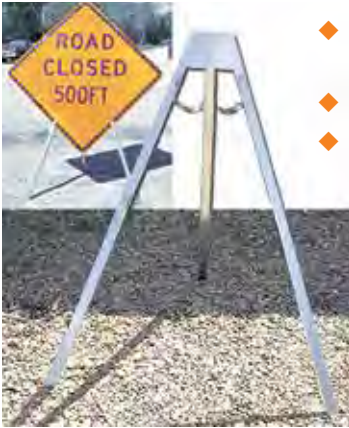

- ◆ For Roll-Up and Rigid Signs
- ◆ 3 Flag Holders
- ◆ 53" High, 14 lbs.

GSS3 Galvanized Step Sign Stand

- ◆ For Roll-Up Signs
- ◆ Pointed for ground installation
- ◆ 57.5" High, 7 lbs.



NOTE: The GSS-3 and GT-2 stands have not been tested under the NCHRP350 guidelines and may NOT be used on Federal or State roads.

Full-Size Stand



- ◆ For Roll-up & Rigid Signs
- ◆ 2 Sizes: (5' / 60") or (7' / 84") above grade clearance

RPOTTC2S2Z4602S (5' / 60")
RPOTTC2S2Z4842S (7' / 84")

- ◆ Heavy-duty dual springs
- ◆ Bright Orange, UV Stabilized, Powder Coated Legs, for Safety, Durability & Visibility

RC101 Compact Stand



- ◆ Non-Wind deflectable economical stand for Roll-Up Signs



RPOTTCRC101

- ◆ NCHRP-350 ACCEPTED
- ◆ Folded 7.5"x9.5"x26.5"
- ◆ Extended: 35"x72"x27.5"
- ◆ Weight: 20 lbs.

RC202 Compact Sign Stand



- ◆ Wind deflectable leaf-spring stand for Roll-Up Signs



RPOTTCRC202

- ◆ Folded 7.5"x9.5"x26.5"
- ◆ Extended: 35"x72"x27.5"
- ◆ Weight: 21 lbs.

Guardrail Clamp

- ◆ For Roll-up & Rigid Signs
- ◆ Firmly affixes to guard rails



RPOTTGDS23

RX553 Mid-Size X-Stand

- ◆ For Roll-up & Rigid Signs
- ◆ Sign is 18" above grade
- ◆ Adjustable galvanized legs
- ◆ Heavy duty dual-coil springs
- ◆ 3 Flag holders included
- ◆ Weight: 37 lbs.



RPOTTC2X553

Median Barrier Clamp

- ◆ For Roll-up & Rigid Signs
- ◆ Heavy-duty, 1-piece, 1/4" powder coated steel bracket
- ◆ Four 1/2" T-Handles hold the Clamp securely, Range 5" - 12"
- ◆ Heavy duty dual-coil springs
- ◆ 3 Flag holders included
- ◆ Weight: 24 lbs.



RPOTTCMBC12553



RPOTTCR26000USH Zephyr Stand

Zephyr Stand

- ◆ For Roll-up Signs
- ◆ 28" X 17" X 1/2" recycled rubber base folds to 4" high & has stacking lugs for easy transport & storage.
- ◆ Molded in carrying handles
- ◆ Simple release raises the mast into upright position
- ◆ Weight: 38 lbs.
- ◆ Model in stock has universal sign holder for any style roll-up sign.

Barricade Lights



Type A, C, and 3 Way

- ◆ STOCK ITEM
- ◆ Flasher, steady burn, & OFF
- ◆ 6 Volt battery
- ◆ Incandescent bulb

RSPBL316YY Yellow Lens



Type A & C Solar LED

- ◆ 4-5 year expected life.
- ◆ LED bulbs
- ◆ True Solar Powered light with rechargeable NiMH rechargeable battery included

RSPBL3LSYY Yellow Lens



RSPBL3LDYYSA
Yellow Lens

Type A, C, and 3 Way Solar LED

- ◆ Flasher, steady burn, and OFF
- ◆ 3 Volt high efficiency lights
- ◆ LED bulbs
- ◆ Internal solar panels trickle charge "D" cell alkaline batteries to give a superior long lasting more reliable power source.



Type B Solar LED

- ◆ Solar panel trickle charges "D" Cell alkaline batteries to give a superior long lasting, more reliable power source.
- ◆ 3 Volt high efficiency lights
- ◆ LED bulbs

RSPBLBL3YYSA Yellow Lens
RSPBLBL3RYSA Red Lens



Type B LED

- ◆ Detachable lens available upon request
- ◆ 6 Volt battery
- ◆ LED bulb

RSPBLBL6YY Yellow Lens
RSPBLBL6RY Red Lens



RSPBLZBATTERY06V
6 Volt Battery

Barricade Light Brackets



- ◆ Brackets allow proper alignment of light
- ◆ I.T.E. Specifications require the lights to be mounted with base of the light perpendicular to the ground line
- ◆ Brackets line the light to requirements and have positive stops to eliminate rotation!



RSPBLZHBR1278L
Left Side
Mounting Bracket



RSPBLZHBR1278R
Right Side
Mounting Bracket



RSPBLZHBR1276
Center Mounting Bracket



RSPBLZHBRBARRIERL
Barrier L Mounting Bracket



RSPBLZHBR1277
Z Mounting Bracket
(Not for Diamond Shaped Signs)

Traffic Batons

Batons are Weather Resistant

Batteries last up to 100 hours.

LED lights visible up to 3,000 yards away & last over 100,000 hours.



14" Long Baton Red RSAGFXG410RE

- ◆ 3 Functions: red flashing, warning, and steady
- ◆ Requires 2 X C batteries (not included)

15" Long Baton Red RSAGFXG411TWRE

- ◆ 4 Functions: white flashlight, white flashlight with red flashing, and red flashing/steady
- ◆ Requires 2 X D batteries (not included)



21" Long Traffic Baton

Red/Green/Blue
RSAGFXG408RGB

- ◆ 6 Functions: flashing and steady in red, green & blue
- ◆ Requires 3 X C batteries (not included)



STOP/Slow Hand Paddles

SAVE MONEY by purchasing one of our Economy, Premium or EZ Connect Hand Paddle Kits.

Custom Hand Paddles available by purchasing individual components of your choice. Use the Customized Easy Order Checklist below to build a hand paddle to your specifications. Paddles are universally punched to accept all handle types from CPC.

Use STOP/STOP Hand Paddles in School Zones, and STOP/SLOW Hand Paddles at Events, for Incident Management, or in Construction Work Zones.

Customized Easy Order Checklist

<p>1 Paddle Material Aluminum: <input type="checkbox"/>.040" <input type="checkbox"/>.080" ABS Plastic: <input type="checkbox"/>.125"</p>	<p>3 Legend <input type="checkbox"/>STOP/SLOW <input type="checkbox"/>STOP/STOP (School Zone)</p>	<p>7 Staff Size and Type <input type="checkbox"/>None <input type="checkbox"/>60" <input type="checkbox"/>72" <input type="checkbox"/>Galvanized Steel Conduit <input type="checkbox"/>Wood <input type="checkbox"/>Gray PVC Plastic - <i>must use with 18" PVC handle</i></p>
<p>2 Reflective Type <input type="checkbox"/> (DH) High Intensity Prismatic & Fluorescent Orange Diamond Grade Combo <input type="checkbox"/> (D) ALL VIP Diamond Grade <input type="checkbox"/> (H) ALL High Intensity Prismatic <input type="checkbox"/> (E) ALL Engineer Grade <input type="checkbox"/> NON-Reflective</p>	<p>4 Paddle Size <input type="checkbox"/>18" x 18" <input type="checkbox"/>24" x 24"</p>	<p>8 Shipping Requirement <input type="checkbox"/> Unassembled - Recommended <input type="checkbox"/> Assembled - oversized freight charges may apply and freight damage is more likely to occur.</p>
	<p>5 Handle Type and Size Galvanized Steel Conduit: <input type="checkbox"/>10" Wood: <input type="checkbox"/>12" <input type="checkbox"/>18" Gray PVC Plastic: <input type="checkbox"/>18"</p> <p>6 4.5" Vynafoam Grip <input type="checkbox"/>None <input type="checkbox"/>YES (for conduit handle only)</p>	

"Econo" Kit

"PREMIUM" Kit



Value Minded
 Non-Reflective
 18"x18" hand paddles
 made of .040" aluminum
 with 10" Galvanized Steel
 Conduit Handle
SHP1818SL040BK10C

OPTIONAL
 foam grip
 for conduit
 handles

Vynafoam Grip
HPZFOAMGRIP

- ◆ Use on Conduit Paddle Handles
- ◆ Color: Black • Size: 3/4" diameter X 4.5" long
- ◆ Soft, velvet-like finish with the comfort of foam and durability of vinyl.



STOP/SLOW

Durable Reflective 18" x 18" hand paddles made of .080" aluminum
 High Intensity (H) reflective with 60" Conduit Staff

SHP1818SL080HK60C

EZ Connect Hand Paddle Kits
The Leader in Safety and Convenience



.125" Black ABS plastic sign on
 Gray PVC "Snap Together" plastic handle

NON CONDUCTIVE

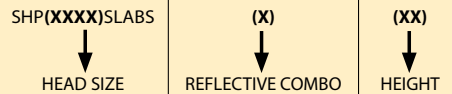

- ◆ Meets Federal Specifications
- ◆ Non-Conductive, Non-Corrosive, Lightweight
- ◆ No couplings or threads involved.
- ◆ 12" Handle can be used by itself as a hand paddle or attach to a staff.
- ◆ 2 Head Sizes:
 18" x 18" (1818) Paddle - 4.6 lbs.
 24" x 24" (2424) Paddle - 5.6 lbs.
- ◆ 2 Staff Lengths: 72" (72) or 84" (84) to bottom of sign

EASY
 Connect
 or Disconnect
 in a **SNAP!**

Choose from 4 Reflective Combinations:

High Intensity Prismatic Fluorescent Orange Diamond Grade Combo (DH)	ALL VIP Diamond Grade (D)	ALL High Intensity Prismatic (H)	ALL Engineer Grade (E)
--	--	---	---

Reflective Roll Conversion

Don't buy \$3000 worth of reflective and graffiti overlay to fabricate \$500 worth of signs Ever Again! Lower your inventory and improve your sign shop's cash flow, by purchasing reflective roll material by the square foot. (1 sq ft min to unlimited)

- Quick Shipments with many Colors and Widths available.
- Reflective ASTM types I, III, IV, IX, XI available. Other types may be available on request.
- Certifications for materials available from manufacturer.

Also Available: EC Film, Graffiti Overlays, Magnetics & Sheeted Blanks



Call for Details

3M High Intensity Prismatic



3M™ 3930 meets all requirements for ASTM Type III and IV.

HIP is the most common type of reflective sheeting today due to the combination of its minimum retro-reflectivity, exceptional warranty, and afford-ability!

High Intensity Prismatic Series 3930		RSH (393X) (2450)	
Common Sizes	Colors	COLOR	SIZE
6" x 50 yds 9" x 50 yds	White(3930) Yellow(3931)		
24" x 50 yds 30" x 50 yds	Red(3932) Orange(3934) Blue(3935)		
36" x 50 yds 48" x 50 yds	Green(3937) Brown(3939)		

NOTE: Other sizes available. Some colors and sizes may incur a \$25.00 Slit Fee.

3M Engineer Grade Prismatic



3M™ 3430 meets all requirements for ASTM Type I reflective.

Engineer Grade Prismatic is an innovative prismatic sheeting designed to replace the traditional glass bead Engineer Grade.

Engineer Grade Prismatic Series 3430		RSH (343X) (2450)	
Common Sizes	Colors	COLOR	SIZE
6" x 50 yds 9" x 50 yds	White(3430) Yellow(3431)		
24" x 50 yds 30" x 50 yds	Red(3932) Blue(3435)		
36" x 50 yds 48" x 50 yds	Green(3437) Brown(3439)		

NOTE: Other sizes available. Some colors and sizes may incur a \$25.00 Slit Fee.

Specialty & Flexible Reflectives



We stock **Nikkalite® Series 48000** Flexible pressure sensitive in most colors. The Best for Plotting and Weeding! Gold and Black Reflective options available.

We also distribute **3M™ 680** and **Avery Graphics** specialty reflectives.

Engineer Grade Series 48000		RSH(48XXX)(2450)	
Common Sizes	Colors	COLOR	SIZE
24" x 50 yds 30" x 50 yds	Black(48003) Yellow(48004)		
	Blue(48006) Green(48008) Gold(48010)		
	White(48012) Red(48025)		

NOTE: Other sizes available. Some colors and sizes may incur a \$25.00 Slit Fee.

Engineer Grade

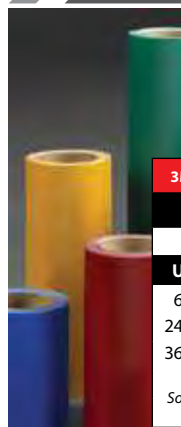

3M™ 3200 Series & Nikkalite® 8100 Series Engineer Grade meets all requirements for ASTM Type I reflective and is ideal for flat surfaces.

3M™ Series 3200 & Nikkalite® Series 8100		RSH (XXXX) (2450)	
Punched Roll Size	3M™	Colors	Nikkalite®
15" x 50 yds	(3290)	White	(8112P)
UN-Punched Roll Sizes		Yellow	(8104P)
6" x 50 yds 9" x 50 yds	(CW84)	Orange	(8177P)
24" x 50 yds 30" x 50 yds	(3272)	Red	(8105P)
36" x 50 yds 48" x 50 yds	(3275)	Blue	(8106P)
	(3277)	Green	(8108P)
	(3279)	Brown	(8109P)

NOTE: Other sizes available. Some colors and sizes may incur a \$25.00 Slit Fee

3M Diamond Grade



Meets ASTM reflective: **3M™ Diamond Grade Cubed Series 4000** Type XI | **3M™ VIP 3990** Type IX | **3M™ 3924** Type VIII

NOTE: Other sizes available. Some colors and sizes may incur a \$25.00 Slit Fee.

3M™ Series 4000, 3M™ Series 3990 and 3M™ Series 3924			RSH (XXXX) (2450)	
Sheeting Description	Common Sizes	Colors	COLOR	SIZE
DG3 4000 Series (Type XI)	24" x 50 yds 30" x 50 yds 36" x 50 yds 48" x 50 yds	White(4090) Yellow(4091) Red(4092) Blue(4095) Green(4097)		
DG Fluorescent Colors 4080 Series - DG3 3980 Series - VIP	24" x 50 yds 30" x 50 yds 36" x 50 yds 48" x 50 yds	Yellow-Green(4083) (3983) Yellow(4081) (3981) Orange(4084)		
VIP 3990 Series (Type IX)	6" x 50 yds 9" x 50 yds 24" x 50 yds 30" x 50 yds 36" x 50 yds 48" x 50 yds	White(3990) Yellow(3991) Red(3992) Blue(3995) Green(3997)		
Fluorescent Orange 3924 Series (Type VIII)	24" x 50 yds 30" x 50 yds 36" x 50 yds 48" x 50 yds	Fluorescent Orange(3924)		



**Buy Reflective Sheeting
by the Square Foot or Roll.**
- Call for Availability -

3M™ Electro Cut™ Film

3M™ Electro Cut™ Film Series 1170 is a durable, transparent acrylic color film allowing traffic signs to be made on a computer plotter while maintaining the sheeting warranty.

Electro Cut Film Series 1170 & Premium Vinyl Series 7725-12			RSH (XXXX) (1850)
Product	Common Sizes	Colors	COLOR SIZE
EC Film Series 1170	18" x 50 yds 24" x 50 yds 30" x 50 yds 36" x 50 yds 48" x 50 yds 15" x 50 yds punched	Clear(1170) Yellow(1171) Red(1172) Orange(1174) Blue(1175) Green(1177) Black(1178) Brown(1179)	
Black Premium Vinyl Series 7725-12	24" x 50 yds 30" x 50 yds 36" x 50 yds 48" x 50 yds <i>NOTE: Other sizes available.</i>	Black (7725-12)	

3M™ Protective Overlay Film

3M™ Protective Overlay Film Series 1150 is a durable, solvent resistant, transparent film with pressure sensitive adhesive, which is applied as a protective overlay to signs made from 3M™ reflective sheetings. As a protective overlay, the film is a barrier to stains made by many types of graffiti.

3M™ Premium Protective Overlay Film Series 1160 Premium is a durable, high-performance, solvent-resistant, transparent film with pressure sensitive adhesive which is applied as a protective overlay to signs made from 3M™ reflective sheetings.

Product	Common Sizes	Colors
Protective Overlay Film Series 1150	24" x 50 yds 30" x 50 yds 36" x 50 yds 48" x 50 yds	Clear (1150)
PREMIUM Protective Overlay Film Series 1160	12" x 50 yds 18" x 50 yds 24" x 50 yds 30" x 50 yds 36" x 50 yds 48" x 50 yds	Clear (1160)

*NOTE: Other sizes available.
Some colors and sizes may incur a \$25.00 Slit Fee.*

Common types of defacement from vandalism can be cleaned from this film.

Avery Premium Vinyl

The new industry standard in high performance film, in a spectrum of 26 opaque colors. Unrivaled in durability, versatility, performance, and ease of cutting and weeding.



*NOTE:
Other sizes available.
Some colors & sizes may incur a \$25.00 Slit Fee.*

Conform-ability: Rivets/Corrugations, Compound Curves
Print-ability: CAS, Thermal Transfer
Adhesive: Permanent
Gloss: 90
Liner: Kraft
Type: Cast V
Other Colors Available. Call for details.

Product	Common Sizes	RSHA8 (XXX) (1550)
Intermediate Opaque Film	15" x 10 yds 15" x 50 yds 24" x 10 yds 30" x 50 yds <i>Other sizes available</i>	COLOR SIZE

001 White	090 Black	130 Medium Yellow	140 Sunflower	150 Dark Yellow	160 Orange	205 Parchment	220 Beige	250 Imitation Gold
295 Brown	325 Tomato	330 Cardinal Red	345 Fire Red	350 Dark Red	370 Burgundy	465 Purple	530 Olympic	555 Medium Blue
	570 Vivid Blue	575 Interstate Blue	580 Sapphire Blue	597 Dark Navy Blue	620 Teal	670 Kelly Green	685 Forest Green	693 Dark Green



Find Application Tools & Accessories on the page 46

We carry all the tools you need for a smooth application



Other Colors Available. Call for details.

Avery Intermediate Vinyl

Cost effective, 4-year intermediate high gloss film for short term signage. Available with vinyl to the edge in 15 colors!

*NOTE:
Other sizes available.
Some colors & sizes may incur a \$25.00 Slit Fee.*

Conform-ability: Flat
Print-ability: CAS, Thermal Transfer
Adhesive: Permanent
Gloss: 90
Liner: Kraft
Type: Calendered Vinyl

Product	Common Sizes	RSHA4 (XXX) (1550)
Intermediate Opaque Film	15" x 50 yds 24" x 50 yds	COLOR SIZE

001 White	077 Silver	090 Black	110 Primrose Yellow	155 Apricot	159 Pizazz Orange	247 Gold
320 Cherry Red	330 Cardinal Red	335 Geranium Red	562 Azure Blue	564 Flex Blue	583 Royal Blue	589 Mariner Blue
						685 Forest Green